

Customer

Project Name

Engineer

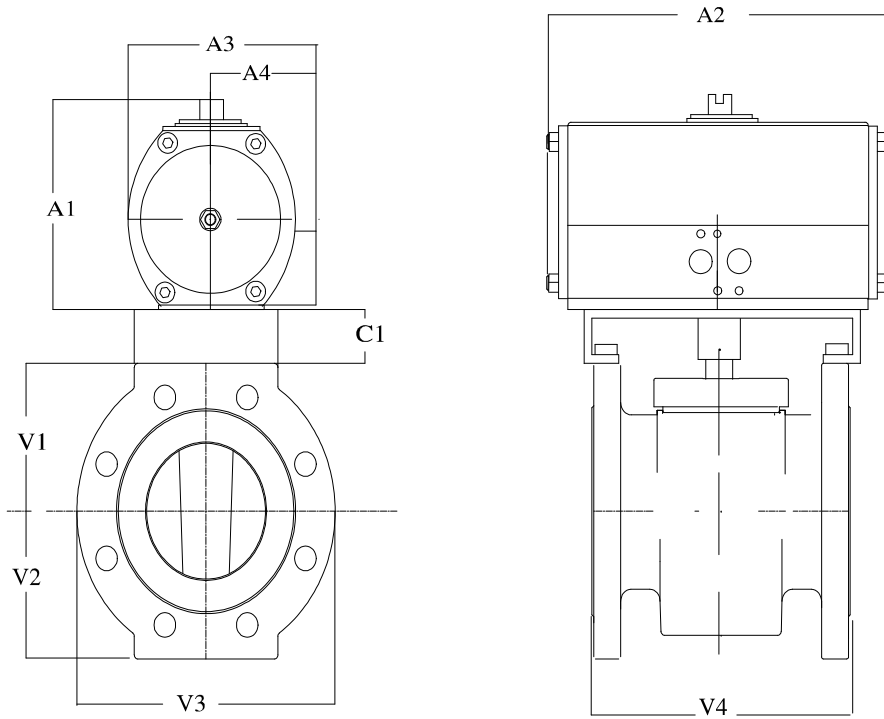

Product Code: 1R302/F/TSR20-WCB/316-P

Valve Type: 1 inch Fluoroseal Sleeved Plug Valve Ansi Class 300
Body: Flanged
Trims: 316
Seat/Liner: Teflon

Working Pressure: 720 psi

Actuator Type: TSR 020 F07 0 3 Fail Close/ Fail Open
Actuator Mat.: Aluminium Hard Anodised

Manual Override: NOT REQUESTED

Air Supply: 60 psi

Solenoid Valve: NOT REQUESTED

Switch Box: NOT REQUESTED

Positioner: NOT REQUESTED

Acc Bracket: By Fluoroseal

Dim:	A1	A2	A3	A4	V1	V2	V3	V4	C1
Ins:	6.32	8.58	5.37	2.83	2.44	2.44	4.88	6.55	1.00

Overall Height to c/l of valve:- 9.76 ins

Num bolt holes :- 4 Bolt dia:- 0.75 Bolt circle dia:- 3.50



Fluoroseal

Issued By: Fluoroseal

File Ref: Automated packages

ALL RIGHTS RESERVED

Date: 8/5/2008