

FluoroSeal Inc.

Specialty Valves



SEVERE SERVICE (FE)

SLEEVED PLUG VALVES — SEVERE SERVICE (FE)



SEVERE SERVICE (FE) PLUG VALVES

FluoroSeal Inc. has developed the Severe Service (FE) Sleeved Plug Valve for tight emission control in more demanding applications. This valve is intended for applications in processes involving thermal cycling or a high number of mechanical operations. This compact but robust package is based on the standard FluoroSeal® Sleeved Plug Valve design combined with other proven seal technologies.

Extensive field experience has demonstrated this valves' ability to perform in a variety of severe applications. FluoroSeal® Severe Service (FE) Valves have one of the best fugitive emissions test results on the market, as demonstrated by independent lab testing.

Please ask your local Representative for a full fugitive emission test report.

DIN valves are available upon request.



ANSI/ASME Severe Service (FE) FluoroSeal® Plug Valve

Standard lockout capability and solid position stop.

Primary shaft seal extrusion is controlled with reinforced PTFE end rings, secondary shaft seal utilizes tight gap metallic shaft for full metal containment.

PTFE sleeve provides in-line and primary external seals. Performance is enhanced with full encapsulation at port opening and precise body ribs to focus sealing forces on plug.

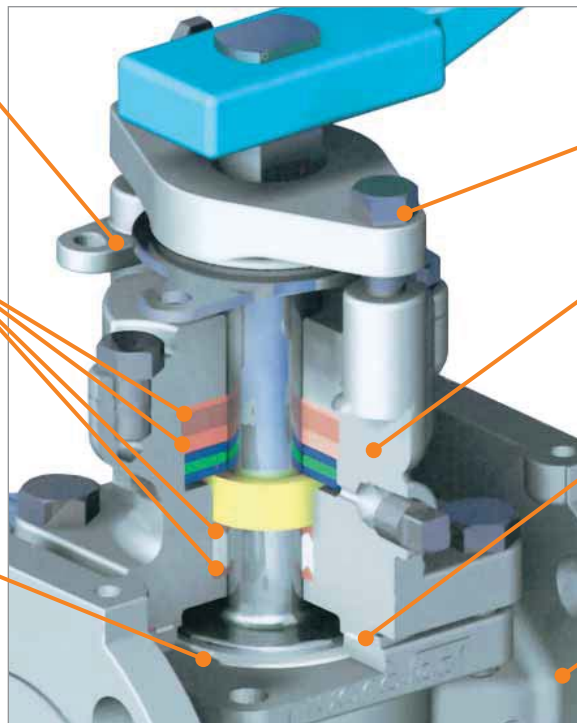

In-line seal adjustable independent of shaft seal.

Innovative shaft seal provides self-adjusting, redundant and independent packing available in all PTFE or PTFE and flexible graphite combinations. Configured for optional monitoring or injection port.

Bonnet is double sealed with fully contained independent PTFE and flexible graphite seal backing up the primary seal at the sleeve.

Precision (investment) cast body provides tight dimensional control to assure concentricity between plug and body. This minimizes induced side loads to the primary seals and shaft seals during operation.

PLUG-ANSI-DIN-R003-2012

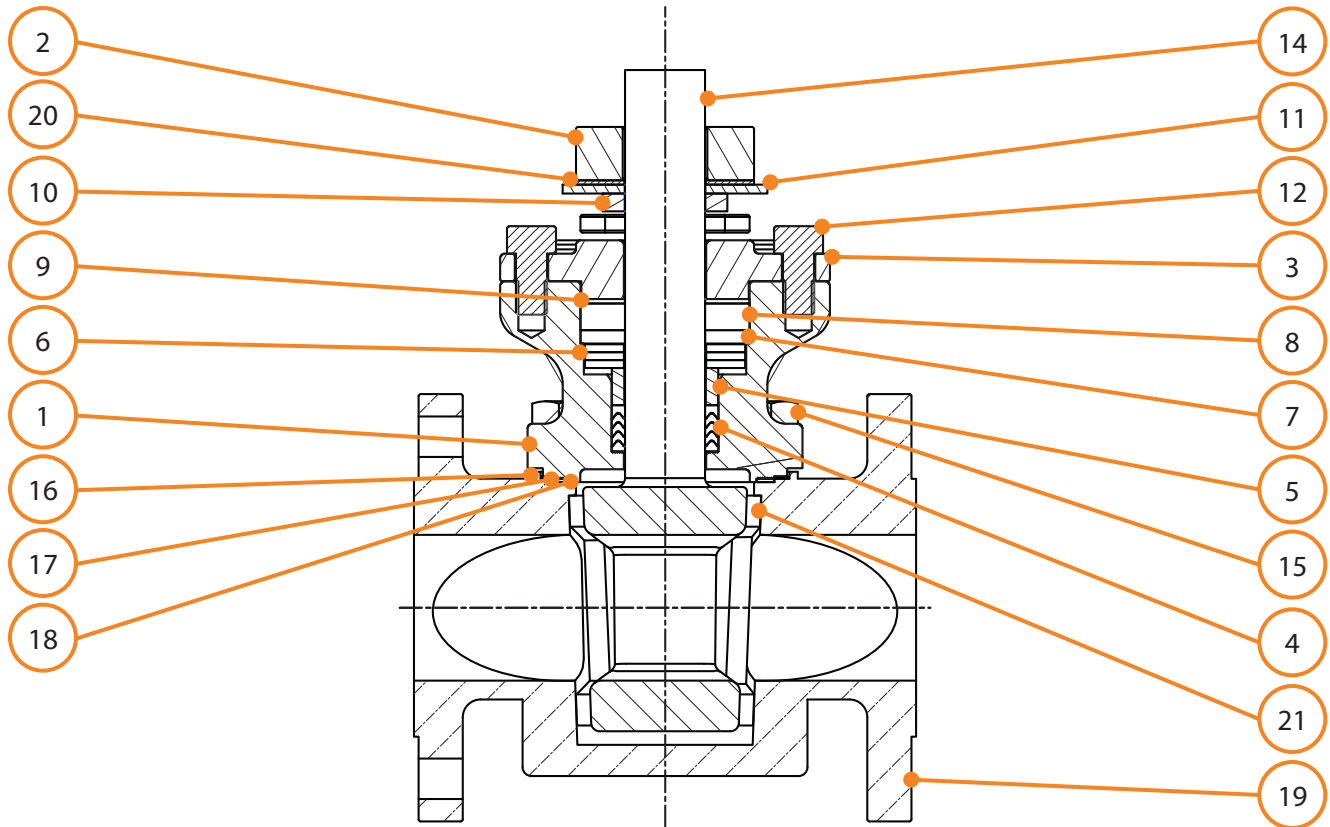

MATERIALS OF CONSTRUCTION

Item	Quantity		
1	1	Bonnet	Customer Specified
2	1	Plug Adjuster	CD4MCu
3	1	Packing Gland	CD4MCu
4	1	Packing Set	Carbon Filled PTFE & Virgin PTFE
5	1	Follower	Customer Specified
6	3	Belleville Washer	PH 17-7 or INCONEL®
7	1	Seal Washer	NITRONIC 60®
8	1	Top Packing	Flexible Graphite or PTFE
9	1	Seal Retainer	NITRONIC 60®
10	1	Shaft Adapter	304 Stainless Steel
11	1	Stop	304 Stainless Steel
12	2	Packing Bolt	304 Stainless Steel
13	2	Plug Bolt	304 Stainless Steel
14	1	Plug	Customer Specified
15	4	Bonnet Bolt	Customer Specified
16	1	Body Seal Retainer	Customer Specified
17	1	Body Seal	Flexible Graphite
18	1	Body Seal	Virgin PTFE
19	1	Body	Customer Specified
20	1	Thrust Washer	Carbon RPTFE
21	1	Sleeve	Virgin PTFE
22	1	Handle	Carbon Steel
23	1	Handle Bolt	Carbon Steel
24	1	Pipe Plug	316 Stainless Steel

This product is engineered for each application and is available in many alloys as well as custom configurations.

SLEEVED PLUG VALVES — SEVERE SERVICE (FE)

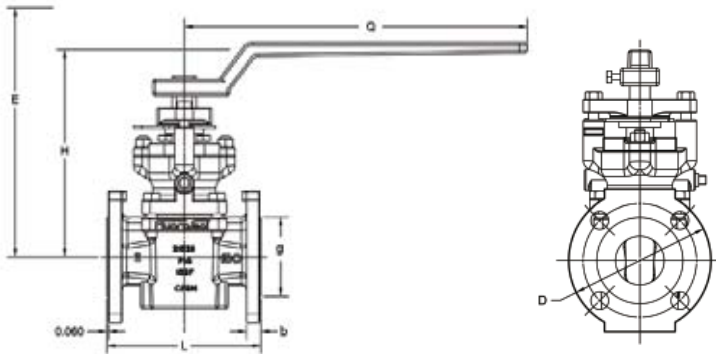

SEVERE SERVICE (FE) ANSI/ASME CLASS 150/300/600 LBS

E = Clearance required for resleeving measured from center line
 Larger dimensions available on request

SIZE	H		E		
	in	mm	in	mm	
1/2"	8.09	205.49	7.80	198.12	For all other dimensions see 2-Way ANSI/ASME Class 150 / 300 / 600 Lbs on page BA2 – BA3
3/4"	8.09	206.49	7.80	198.12	
1"	8.50	215.90	9.94	252.48	
2"	10.25	260.35	12.75	323.85	
3"	10.50	266.70	14.38	365.25	
4"	12.50	317.50	17.62	447.55	
4" EG	13.75	349.25	17.62	447.55	
6" EG	20.25	514.35	23.75	603.25	
8" EG	23.25	590.55	31.00	787.40	
10" EG	24.81	630.17	35.00	889.00	
12" EG	23.25	590.55	-	-	